

# TECHNICAL GUIDELINES



**CONTENTS**

BELENCO QUARTZ SURFACES .....	03
BELENCO IS UNIQUE .....	04
10 REASONS TO CHOOSE BELENCO .....	05
BELENCO APPLICATION AREAS .....	06
BELENCO TECHNICAL SPECIFICATIONS .....	07
Mohs Hardness Scale .....	08
Chemical Resistance .....	08
Heat Resistance .....	09
Fire Resistance .....	09
Luminosity .....	09
BELENCO INDICATIVE TECHNICAL CHARACTERISTICS .....	10
BELENCO PHYSICAL PROPERTIES .....	11
Weight .....	11
Dimensions .....	11
BELENCO SAFETY AND HEALTH NOTICE .....	12
ENVIRONMENTALLY FRIENDLY PRODUCTS .....	13
ENVIRONMENT FRIENDLY PRODUCTION .....	14
BASIC GUIDELINES FOR WAREHOUSING AND FABRICATION .....	15
SLAB HANDLING .....	16
SLAB STORING .....	16
FABRICATION INSTRUCTIONS .....	18
Material Selection and Preparation .....	18
Measurements .....	18
Cutting Principles .....	19
Distance between Cooker and wall .....	21
Edge Profiles .....	21
Polishing Edge Profiles .....	22
Lamination .....	22
Seaming .....	23
Miltered Edges .....	24
Adhesives .....	24
INSTALLATION INSTRUCTIONS .....	25
Transportation of Materials .....	25
Preparing the Job Site .....	25
Installation .....	26
Wallpanel Installation .....	27
After Application .....	27

bele<sup>®</sup>nco  
●●● quartz surfaces



## ●●● BELENCO QUARTZ SURFACES

Belenco manufactures in two production facilities located in Manisa Organized Industrial Zone in a total of 63,724 m<sup>2</sup>, 38,634 m<sup>2</sup> of which is closed area.

Since 2011, Belenco produces natural quartz surfaces with state-of-the-art technology of Breton S.p.A, Italy based leader company of natural and composite stone technology machinery with 3 casting and 4 polishing lines.



## BELENCO IS UNIQUE

Belenco demonstrated its R&D and Innovation vision since the first years of its establishment, naming the corporation: Peker Surface Designs Industry and Trade INC. showing that the design is the driving force for the company.

This vision, combined with strong investment policies, has given Belenco the privilege of being the “first” in various fields:

**2011** - After its establishment, Belenco quickly became the country’s most prominent exporter and fashion leader in its sector.

**2014** - Became the first producer and exporter of ready to be processed quartz surface category with its Belenco Plus investment.

**2015** - Increased the capacity by 100% with the help of second line investment, and

**2016** - Partnered with USA-based investment firm Darby Overseas.

**2017** - Produced Turkey’s first ever long vein quartz surfaces following Robotic Arm investment,

**2018** - Received the title of being the first R&D Center approved by the Ministry of Science, Industry and Technology in its sector.

**2019** - Partnership was established with Lotte Chemical Group (South Korea),

**2020** - During the year, the new factory area of 27 thousand 534 square meters was completed and the 3rd line production started. With the addition of the second facility, Belenco has reached a production capacity of 2 million square meters in a total facility area of 63,724 m<sup>2</sup>; taking its place among the world’s leading quartz surface producers.



# 10 Reasons to Choose Belenco

## 01 Design

Belenco, with its rich product range, inspires the limitless imagination of the interior designers who are looking for unique solutions. Its power comes from being the first and only R&D Center in its sector in Turkey. Belenco is the trendsetter, leading brand of the sector with its unique surface designs harmonious with the world design trends. It is the only brand in Turkey with international awards in its field. The surfaces produced by Belenco are crowned with the world's most prestigious design awards.

## 02 Natural Material & Natural Shine

Luster of Belenco Quartz Surfaces comes from the natural sheen of the inherent quartz minerals. Belenco Quartz Surfaces do not contain any gloss improving agents and can maintain its luster without any sealants or waxes.

## 03 Color Consistency

Color and pattern consistency is an indispensable standard. Tone and texture consistency is essential for slabs with the same production date. The problem of not achieving product continuity in other types of countertop materials, especially in large-scale projects, is not experienced in Belenco.

## 04 Durability

The natural quartz, an extremely strong and durable mineral stone, combines with excellent design and technology in Belenco Quartz Surfaces to form a surfacing material with high abrasion, scratch and impact resistance.

## 05 Stain Resistance

Belenco is a stain-resistant surface with a non-liquid absorbent non-porous structure. Quartz, which constitutes more than 90% of its composition, eliminates the corrosive effects of chemicals. Substances that may cause permanent staining or abrasion on other countertop materials such as tea, coffee,

vinegar, lemon, and colored spices do not affect Belenco.

## 06 Hygiene

Belenco Quartz Surfaces do not allow bacteria or microorganism to grow on it thanks to its non-porous and compact structure. It has a hygiene report issued by LGA Qualitest GMBH, confirming that Belenco is easily cleanable surfacing material that is totally safe with respect to post-cleaning microbiological hygiene. NSF proves Belenco to be thoroughly safe for direct contact with any kind of food and for use in areas where food preparation could take place.

## 07 Easy Maintenance

Belenco maintains its first day shiny look and natural vitality for many years with a simple daily cleaning. A damp cotton cloth and a small amount of soft neutral liquid soap (dish soap, etc.) are sufficient for daily cleaning.

## 08 Eco-friendly and Sustainable

Quartz is one of the most abundant minerals in nature, therefore Belenco Quartz Surfaces are sustainable and environmentally friendly products. Due to their resistance against wear and tear, Belenco Quartz Surfaces are eco-friendly with their investment in savings and recycling technologies provided in cleaning expenses.

## 09 Safe For Human Health

Belenco Quartz Surfaces do not cause any harmful gas emission for human health. This feature has also been certified by a prestigious International Institution Greenguard. GREENGUARD Indoor Air Quality Certificate and GREENGUARD certifies that Belenco is a low emission product that does not spread harmful toxic chemicals to the air.

## 10 Recognition And Reliability

Belenco, the brand preferred and trusted by industry professionals, is Turkey's export champion and domestic market leader in it's field.

\* According to export and domestic sales data by years.

## ●●● Belenco Application Areas



In addition to the primary use of Belenco Quartz Surfaces as kitchen countertops and bathroom vanities in residential areas, other application areas successfully include flooring, cladding, staircasing, madallion applications, service countertops, backsplashes and tabletops. Belenco not only makes it possible for elegant and smart applications in floorings thanks to its high scratch resistance, but also in cladding with its fabulous texture alternatives, in counter- and worktops owing to its stain-free hygienic structure and laboratory worktops thanks to its chemical resistance as well as in backsplashes thanks to its uniform outlook with countertops.

Belenco is inspirational for those who seek the best and gets inspired from any fantasy. It can be used directly proportional with the creative power of living space designers in any space where hygiene and strength come together to form into grace.

### **Belenco provides a solution for every design.**

- Kitchen countertops
- Bathroom vanities
- Flooring
- Wall cladding
- Backsplashes
- Shower and tub surrounds
- Staircases
- Madallion applications
- Tabletops and worktops
- Reception and service countertops
- Elevator cab walls and floorings

and many other original designs...



## Belenco Technical Specifications



### Scratch and Abrasion Resistance \*

Belenco Quartz surfaces is substantially harder than natural stone and is highly resistant to scratching. However, avoid damage by refraining from using knives, screw drivers and other sharp objects directly on the surface. Never cut or chop directly on the surface, always use a cutting/chopping board when preparing foods.

\* Quartz is one of the strongest and most functional natural stones. It is very hard and highly durable with a supreme level of scratch and abrasion resistance showing also high resistance against aggressive effects of chemicals.

## Mohs Hardness Scale

The higher the percentage of quartz mineral present in a surface material is, the stronger and more durable it gets. The superior quality of Belenco Quartz Surfaces composed of approximately 90% quartz mineral is ensured by the high quality raw material supplied from the best quality sources.

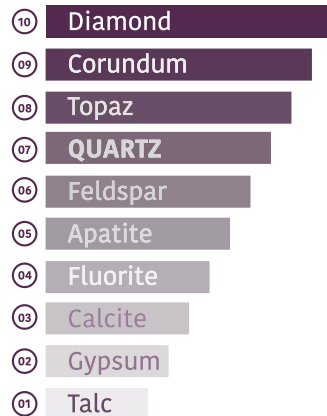

- 
- ⑩ Diamond ● Hardest of all minerals, only scratched by very strong laser
  - ⑨ Corundum ● The ones that can scratch Topaz
  - ⑧ Topaz ● The ones that can scratch glass by force
  - ⑦ **QUARTZ** ● **The ones that can scratch glass by force**
  - ⑥ Feldspar ● The ones that can be scratched by rasp
  - ⑤ Apatite ● The ones that can be scratched by rasp
  - ④ Fluorite ● The ones that can be scratched by steel blades
  - ③ Calcite ● The ones that can be scratched by copper coin
  - ② Gypsum ● The ones that can be scratched by nail
  - ① Talc ● The ones that can be scratched by nail easily
- 

## Chemical Resistance

### Acids

Belenco Quartz Surfaces are resistant even against the strong solutions of widely used acids such as hydrochloric acid, nitric acid, and sulfuric acid. Yet, discoloration or other damage may occur on the surface if concentrated solutions are left to stay over 1 hour on the surface due to their aggressive effects on the polyester resin and pigments.

### Bases

Bases that would affect Belenco Quartz Surfaces are sodium hydroxide and potassium hydroxide concentrations. Although not affecting the product on a structural basis, these substances may give rise to surface damage within time. These high concentration bases must be instantly removed from the surface. Low sodium and potassium hydroxide concentrations in household chemicals do not affect Belenco Quartz Surfaces provided that they are instantly and thoroughly rinsed. However, the use of highly concentrated strong oil remover solvents is not recommended.

### **Solvents**

Belenco Quartz Surfaces are resistant against many commercial and industrial solvents. Solvent containing household chemicals do not affect Belenco surfaces within a short period of contact. Aggressive effects of solvents as pure at high concentrations such as acetone, lacquer thinner, mineral spirits, isopropyl alcohol, methylene chloride, trichloroethane and methyl ethyl ketone can be tolerated for a short period of time. Yet, surface contact with such substances must be avoided.

### **Staining Agents**

Belenco Quartz Surfaces are resistant against the aggressive effects of staining agents used in laboratories. Concentrations of pure betadine or high concentration iodine do not leave permanent marks on Belenco for short contacts less than 1 hour. (On many solid surfaces and plastic surfaces these agents produce permanent stains.)

### **Our recommendations!**

We recommend that cleaning agents with a pH value of 5-8,5 be used when cleaning Belenco Quartz Surfaces. Cleaning products with other pH values (such as oven and grill cleaners, floor cleaning machine products, water closet cleaners, rust removers, oil removers, furniture cleaners, drain cleaners and etc.) may give damage to the surface within time. In case that such products contact with the surface, the surface must be thoroughly rinsed with generous amount of water right away. Its high chemical resistance makes Belenco a stain proof surface. Substances like coffee, tea, wine, mustard, vinegar and lemon, do not act Belenco provided that they do not come into direct contact for a long time. Thanks to this supreme quality there is no need to use surface protective chemicals on.

Do not use chemicals like thinner, trichloroethane or methylene chloride. Bases with pH value higher than 8.5 and acidic cleaners which contain hydrochloric acid, nitric acid etc will cause discoloration, fading and damage of the countertop's smooth surface. Avoid the use of high pH value cleaning agents as much as possible. In the case of inevitable use, apply these only to the stain and instantly rinse with generous amount of water.

### **Heat Resistance**

Although Belenco is more resistant against high temperatures than other countertop materials, it can be affected by sudden heat changes. Therefore strictly avoid placing any hot kitchenware from oven or cooker and any heat emitting kitchen equipment (such as electrical frying pans) directly onto Belenco surface, and always remember to use a hot pad/trivet.

### **Fire Resistance**

According to reaction to fire test results, Belenco quartz surfaces are class A2fLS1 hard combustible for floors and class A2S2d0 hard flammable for other applications.











### **Luminosity**

Belenco provides world-class, high-quality, fashionable, elegant quartz surfaces. Since its brightness comes from the natural brightness of quartz, there is no need for re-polishing or sealing with a coating. Belenco Quartz Surfaces can only be polished in factory conditions. For this reason, do not try to polish your Belenco Quartz Surfaces afterwards. As a result of this type applications, the surface may get damaged and in this case is cannot be repaired. Belenco maintains its first day's brightness and natural vitality for many years with simple daily cleaning.



# Belenco Indicative Technical Characteristics

Test	Standard		Values
Water Absorption	ASTM C97	%	0,04
	EN 14617-1	%	W4 ≤ 0,05
Density	ASTM C97	lb/ft <sup>3</sup>	150,9
	EN 14617-1	g/cm <sup>3</sup>	Av. 2,3
Breaking Strength	ASTM C648	lbf	3883
Flexural Strength	ASTM C880	psi	Dry: 6809
	EN 14617-2	Mpa	Wet: 6725 F4 ≥ 40
Modulus of Rupture	ASTM C99	psi	Dry: 7379
			Wet: 5585
Bond Strength	ASTM C482	psi	241
Compressive Strength	ASTM C170	psi	Dry: 33369
			Wet: 35446
Impact Resistance	EN 14617-9	joule	≥ 3
Abrasion Resistance	ASTM C501	-	212
	EN 14617-4	mm	A4 ≤ 29
Thermal Shock Resistance	ASTM C484	-	No visible defects.
	EN 14617-6	%	Δm% = 0,48 Δ <sub>31</sub> ,20% = 5
Freeze and Thaw Resistance	ASTM C1026	-	No visible defects.
	EN 14617-5	-	KM <sub>725</sub> = 0,98 Freeze: 1,637*10
Linear Thermal Expansion Coefficient	ASTM E228	%	Thaw: 1,958*10
	EN 14617-11	10 <sup>-6</sup> / °C	19,7
Slip Resistance	EN 14231	-	Dry SRV: 41
			Wet SRV: 4,5
Static Friction Coefficient for Polished Surface	ASTM 1028	-	Dry: 0,76
			Wet: 0,47
Static Friction Coefficient for Seta (Matte) Surface	ASTM 1028	-	Dry: 0,77
			Wet: 0,66
Reaction to Fire Class	EN 13501-1	-	A2 s1 d0
Electrical Resistance	EN 14617-13	Ω	R <sub>s</sub> 3*10 <sup>12</sup>
			R <sub>v</sub> 2*10 <sup>12</sup>
Chemical Resistance	EN 14617-10	-	C4
Thermal Conductivity Coefficient	EN 12664	(W/mK)	0,777
Dimensional Stability	EN 14617-2	-	Class A

	Belenco Quartz Surfaces	Natural Stone (Granite)	Laminate	Acrylic Surfaces
 Scratch Resistance	✓	✓		
 Flexural Strength	✓			
 Breaking Rupture Strength	✓			✓
 Chemical Resistance	✓			✓
 Liquid Impermeability and Non-porousness	✓			✓
 Stain Proof	✓		✓	✓
 Hygiene	✓			✓
 Maintainability	✓			
 Heat	✓	✓		
 Color Stability	✓		✓	✓

# Belenco Physical Properties

## Weight

Weight of slabs differs with size and thickness.

Slab Dimensions	2 cm	3 cm
165x330 cm	250 kg	370 kg
310x152 cm	214 kg	320 kg

\*Average value within tolerances

Remember that slabs are heavy. Therefore, pay maximum attention when carrying and handling of slabs from one place to another.

Size	Weight (kg)	
	2 cm	3 cm
30*30 cm	4	6
50*50 cm	11	16
75*75 cm	25	37
50*100 cm	22	33
75*100 cm	33	50
75*150 cm	50	75

## Dimensions

Belenco Surfaces inspire unlimited creative designs with extra 152x310 cm and jumbo 165x330 cm slabs. With enlarged slab size of Belenco has now made it possible to cut all countertop surface from one single solid slab reducing the need for seams and eliminating the risk of shade and texture differences between different slabs. It is now not only possible, but also easy to design and apply seamless installations of large size surfaces.

Belenco slabs can be precisely sized to project needs in flooring and/or cladding applications. In addition to standard size of 50x50 cm and 30x30 cm tiles, custom-made production is also available.

Size	2 cm	3 cm
165 x 330	•	•
152 x 310	•	•
75 x 150	•	-
75 x 100	•	-
50 x 100	•	-
75 x 75	•	-
50 x 50	•	-
30 x 30	•	-

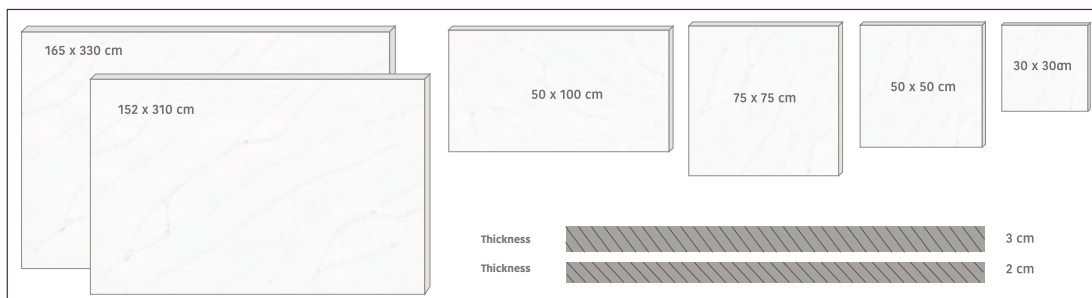



## BELENCO SAFETY AND HEALTH NOTICE

### Safety and Health

Information here under provides the most important safety and health issue pertaining to the fabrication and installation. Please read this carefully to understand how silica dust could cause silicosis and severely and permanently damage your health.

### Crystalline Silica Dust

Quartz is a pure mineral that has the chemical formula  $\text{SiO}_2$  and is crystalline and transparent in structure. Belenco is composed of 93% quartz by weight. No inherent health risks are present in its slab form. However, respirable crystalline silica dust represents a potential health hazard when they are inhaled by a person. The silica dust is created during all operations done dry such as sawing, sanding, drilling or routing. Dry sweeping can also create silica dusts and cause for developing to silicosis.

Overexposure of silica dust can cause silicosis by the formation of scar tissue in the lungs. Silicosis can be disabling, nonreversible and sometimes produce fatal lung disease. Symptoms of silicosis include coughing, difficulty in breathing and progressive impairment of lung function.

Shop operation in a wet environment using proper ventilation and filtration systems would keep any deadly dust airborne for inhaling and prevent shop employees from potential health risks.

### Worker Protection

We encourage all members of the fabrication and installation shop to review the resources of OSHA requirement ([www.osha.gov/silica-crystalline](http://www.osha.gov/silica-crystalline)) and NIOSH recommendation ([www.cdc.gov/niosh/topics/silica](http://www.cdc.gov/niosh/topics/silica)) for preventing silicosis, other silica-related diseases, and engineering controls and work practices providing the best protection for workers. Each employer in the stone fabrication and installation business is responsible for its employee training and day-to-day employee safety and health.

- All fabrication should be done wet
- Wear safety glasses
- Wear leather or cotton gloves
- Air purifying respirator

### First Aid

In case of ingestion, immediately rinse the mouth with water (at least 15 minutes) and consult a physician. In case of inhalation, move to an open and well-ventilated area and consult a physician. In case of eye contact, flush eyes with plenty of water (at least 15 minutes) and consult a physician.

## Environment Friendly Products



In Belenco, quartz, the gift of nature, is produced as a heritage surface not only for today but also for the future, with the philosophy of conscious use of natural resources. Belenco focuses on efficiency at every stage of production in order to transform quartz from nature into surfaces in harmony with nature. In Belenco green facilities, the water used for polishing the slabs produced by vacuum-press-vibration technique is collected for reuse through channels placed along the line. Water collected in this line, where water consumption is the most intense, is treated with advanced treatment technologies and used in the most efficient way by recycling. Dust formation is minimized thanks to the casting performed with a closed system. In order to ensure high indoor air quality, the dust generated is collected at the source with the help of a dust collection system, and the entire air in the production facility is renewed with air circulation every three hours. While an efficient working environment is created with sound, heat insulation and air conditioning and ventilation systems that increase indoor air quality, less energy is consumed. The roof of the factory is made of polycarbon material to provide maximum benefit from daylight for efficient use of energy. In the Belenco green facility with heat insulation, heat losses are minimized and fuel consumption is reduced. Natural gas, which is the most environmentally friendly fuel, is used in production processes.

In the Belenco green production facility, recyclable waste materials such as industrial waste oils, metal, nylon, paper and wood are sent to recycling companies. Wastes that cannot be recycled are converted into minimum harmful for the environment in disposal facilities approved by the Ministry of Environment.

Belenco, aims efficiency at every stage of the product life cycle, values the protection of the natural resources it undertakes in the application areas of its products. Long lasting Belenco quartz surfaces can be enjoyed for years with the first day elegance without wearing out. They don't require frequent replacement or repair. They do not require any special care or maintenance, provide less water and detergent use in cleaning and maintenance processes. It reduces expenses, saves time and energy.

## Environment Friendly Production

Belenco is a member of US Green Building Council (USGBC). With highest respect and deepest commitment for the environment, Belenco Quartz Surfaces produce environmentally friendly products in a USGBC member green factory operating on the principles of efficient resource management, minimum waste and maximum return while also securing human and environmental health at each point of production. With an aim to create better living spaces and a mission to present future generations with an environment of high energy for life, Belenco operates essentially on the principles of preserving natural resources and securing sustainability which are deemed as a strictly observed duty by the company against all its customers, workers, business partners and the community.

Belenco is certified by GREENGUARD. GREENGUARD Indoor Air Quality Certification proves together with GREENGUARD Children and Schools Certification that Belenco is a low-VOC (volatile organic compound) product improving indoor air quality, yet without an emission of any toxic chemical at a harmful level for the indoor air quality.

Accredited by NSF and LGA for hygiene characteristics, Belenco produces charming and safe-to-use high quality products of long lasting and abrasion resistant surfacing material that is easy to use without any special care and maintenance. Hygiene certification by LGA Qualitest GMBH attests Belenco to be an easily cleanable surfacing material that is totally safe with respect to post-cleaning microbiological hygiene while certification by NSF proves Belenco to be thoroughly safe for direct contact with any kind of food and for use in areas where food preparation could take place.

In addition to certification by the Institute of Turkish Standards for compliance with regulatory requirements, manufacturing by Belenco is in accordance with ISO 14001 (Environmental Management), ISO 9001 (Quality Management) and OHSAS 18001 (Occupational Health and Safety Management) systems.





---

## **BASIC GUIDELINES FOR WAREHOUSING AND FABRICATION**

---



## Slab Handling

Although storage, loading and unloading of quartz slabs within warehouse and ateliers show similarities with those of natural stones, some issues need to be paid more attention.

During loading and unloading a lifting device or a forklift is required. Slab weights vary with size and thickness. Any lifting device or forklift that is intended to be used in loading and unloading must be capable of handling at least 900 kg.

Handle slabs in multiples of two that are stored face to face. Use clamps or sling straps for a better grip to prevent slab sliding.

## Slab Storing

Store and transport slabs face to face in multiples of two on a removable “A” frame or vertical piping rack design. This will prevent warping. Place slabs in such a way Polished or Seta (Matte) finishes come face to face in multiples of two to prevent surface polished damage. Store slabs indoors to ensure protection against external conditions.

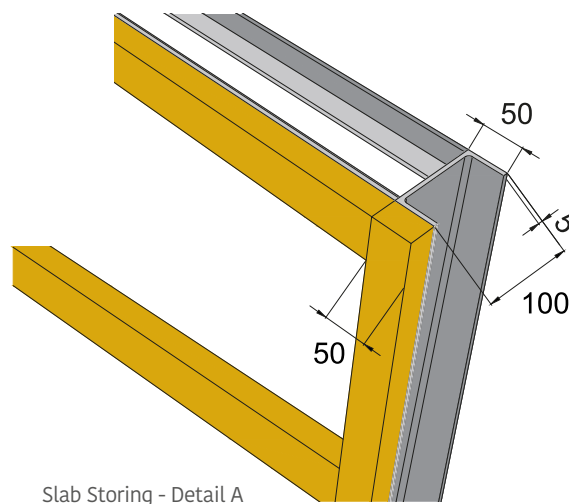
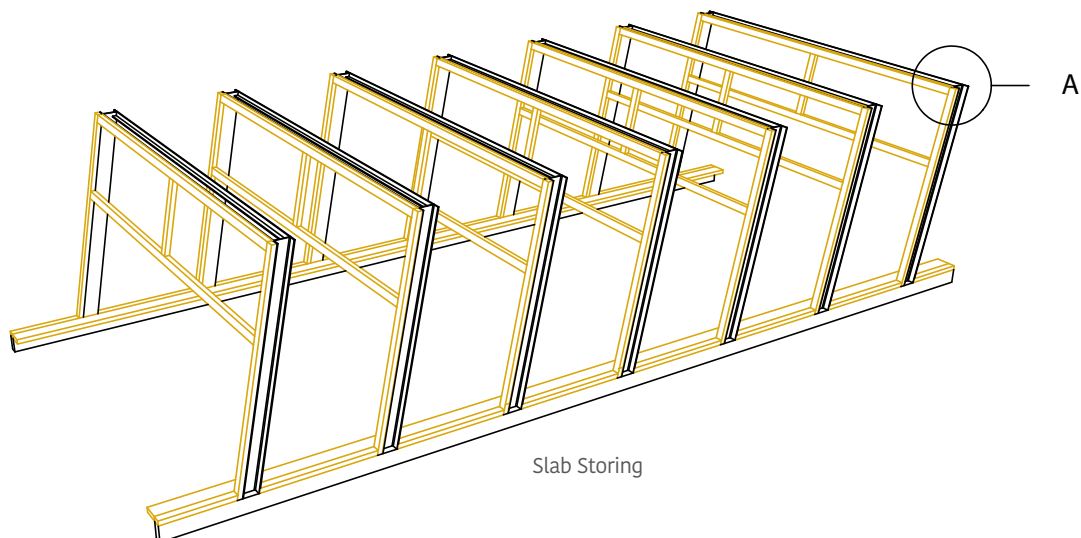

When slabs are not stored correctly, problems like warping, dirt and scratching may occur.

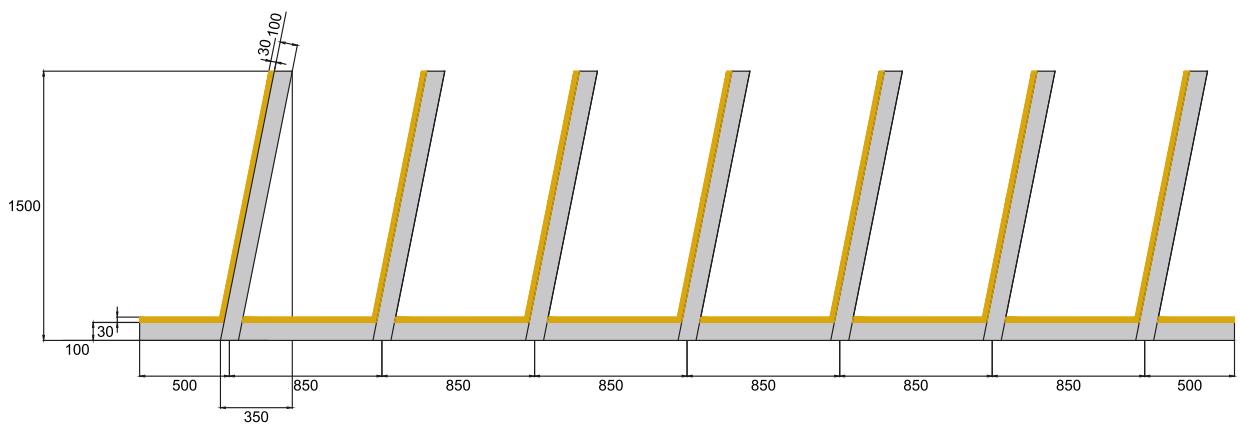
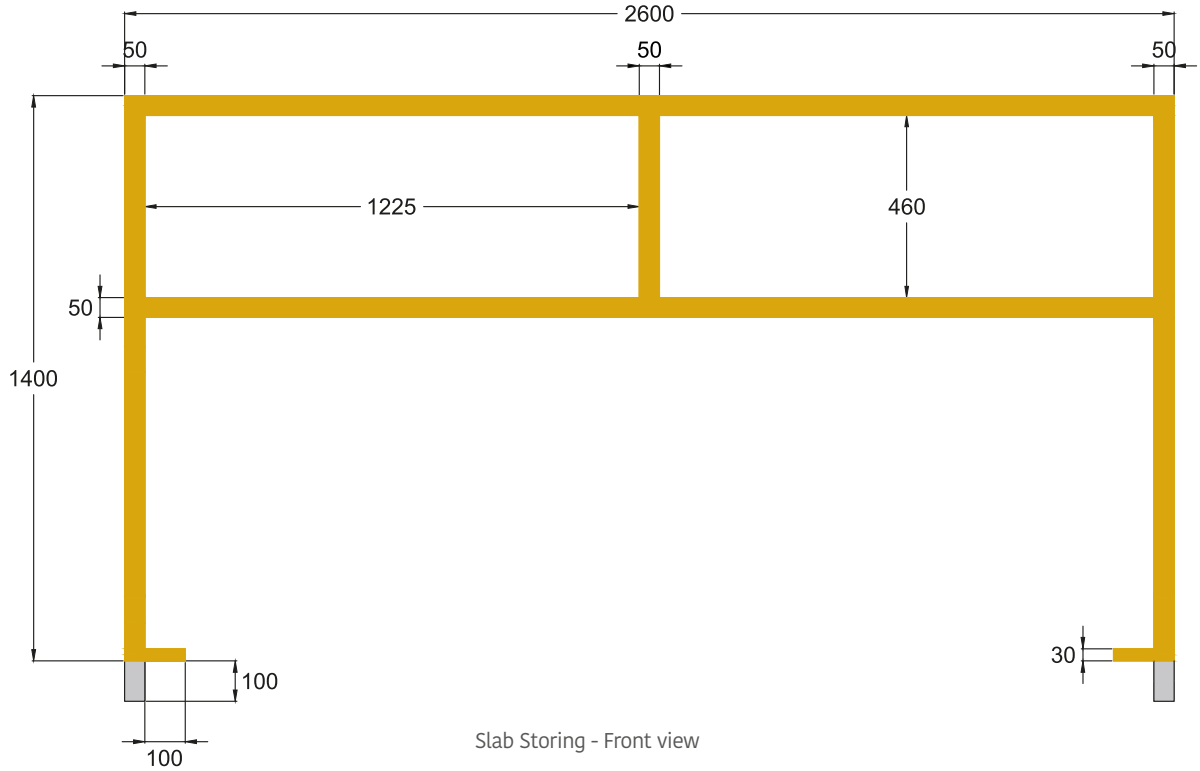



## Fabrication Instructions

Carefully observe the basic instructions in fabricating slabs into countertops and securing proper installation. In order to achieve 100% customer satisfaction, strictly observe the instructions and carefully apply the techniques as described.

### Material Selection and Preparation

- Check if the slab fits for purpose by inspecting under light from different angles.
- Make sure that the readily available slab size is sufficient to complete the intended work.
- If more than one slab is required for the construction of a single countertop and/or backsplash check for color consistency of the slabs. Make sure that two slabs are consistent in terms of color shade, texture and thickness. Show care in using slabs of the same production date. There may be differences in terms of tone, texture and design when products of different production date are used.
- Remove the protective layer before conducting the edge polishing operation.

### Measurements

- If you are to check the measurements in a living place, remember to take shoe covers with you.
- Pay attention to be in time for the prescheduled appointment.
- Make sure you have all the required equipment needed to check the measurements.
- If possible take product samples with you.
- The first step of a good application that would reflect your workmanship and leave your customer satisfied is checking the measurements correctly. Write down notes so that you don't miss anything for later decisions.
- Discuss about and finally determine with your customer all application requests at the actual application site such as cutouts for sink/basin, cooker and fittings, seam positions, edge profiles and all other special application details.
- Remember that you have to do all the cutting, drilling, polishing work in the atelier and that you should not require any alteration at the site of application. Meticulously determine all the details about the actual installation site and write them down.
- Use an unbending and inflexible material such as a cardboard as a template for the application surface at the actual site of installation.
- Leave room for expansion and allow a clearance of at least 3 mm from each wall side within measurements.
- Avoid cutting an L shaped top from one solid piece.
- After you have checked the measurements, review your notes with the customer for confirmation. In order to secure that you have fully and correctly understood your customer's expectations, go over the product and fabrication notes for a final confirmation.
- Ensure that your customer clearly understands that any objections after installation due to personal liking and expectations will not be at your responsibility.
- Remember to leave Belenco Product Brochure and Maintenance & Care Guidelines with your customer.

**Understanding your customer's expectations and request is the first step to customer satisfaction.**

## Cutting Principles

- Before you start with the job, make sure you have taken all the necessary health and safety measures for a proper work environment.
- For cutting, use only water cooled tools to prevent overheating and generating dust. When dry cutting is used, the heat generated can increase the slab cracking, chipping and discoloration. Diamond blade, disc, saw and core bits that are used to fabricate granite are also suitable for quartz slabs.
- Make sure that the cutting blade/saw/disc is in good condition and there is no missing teeth. Any blade/saw/disc that is not in good condition will leave marks at cutting edges.
- Place the slab horizontally on a flat, solid and resistant cutting table. Make sure the cutting table is in good condition.
- Check that the cutting speed is not so high and that the blade/saw/disc is perfectly lined up with the cutting direction.
- Check that there is no warping in the slab to be cut. Warping may result in breakage of the slab during the cutting process.
- It is always recommended to start cutting of the slab by the sides.

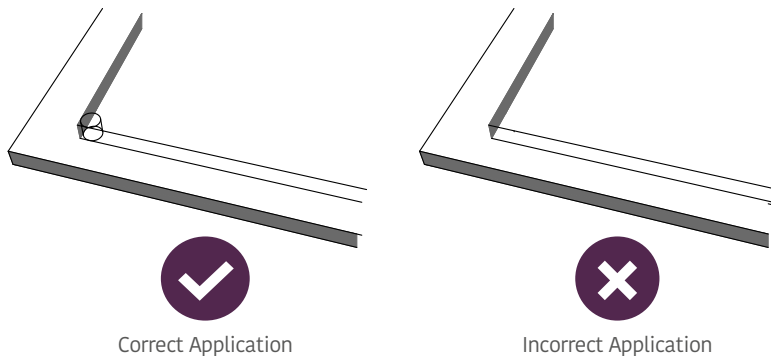

**Cut it by using generous amount of water. Strictly avoid dry cutting and polishing.**

## Drilling a Hole for Sink/Basin

- Place the adhesive tape on the surface of the sink/basin and draw the cutout on the adhesive tape.
- First drill a hole in each corner of the cutout with a core bit of 2-3 cm in diameter. Pay attention that the corners have a rounded shape and avoid 90° square corners.
- Avoid damaging the drilled area with a cutting disc. Damage to the drilled area can result in stress points that may lead to hairline cracks.
- Do not cross the cuts in the corners. The cutting should end in the hole and will never go beyond it.
- If the distance between a cutout and a joint is less than 15 cm, the area needs to be supported by a Belenco strip at least 2 cm thick.
- Always allow an extra clearance of 3 mm between the appliance and the edge of the cutout for expansion.

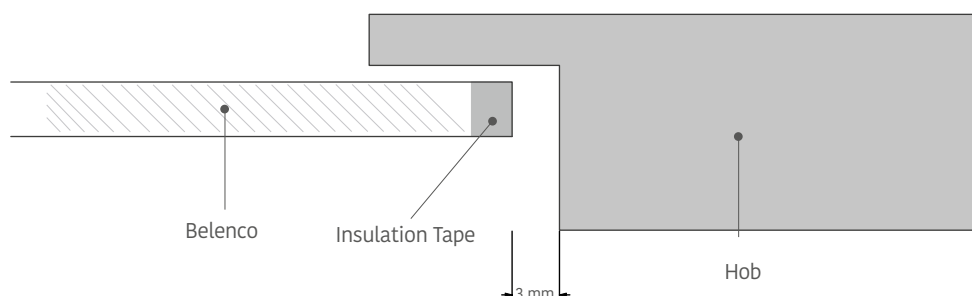

- Make sure all joints are placed at the junction of the base cabinets or a solid Belenco slab be fitted under the joint for support.
- Carry out all cutouts with wet diamond cutting tools. Use generous amount of water to avoid surface overheating and dust formation. Check there is continuous flow of clear water during the cutting process.
- Strictly avoid dry cutting, grinding and polishing as well as excessive surface heating and forming square angles during cutting as these may result in formation of hairline cracks in the future.

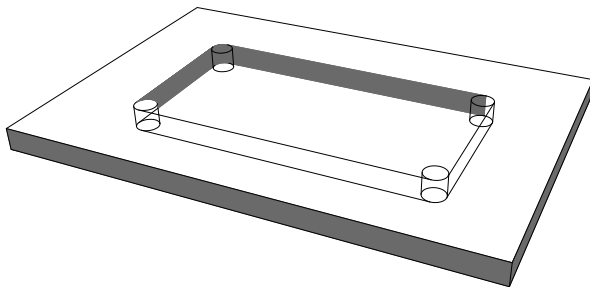

**Pay attention to complete all the fabrication work in the atelier so that you won't need any alteration at the installation site.**

In standard sink usage, the mounting hole opened for mounting on the slab should be up to the maximum half of the slab.

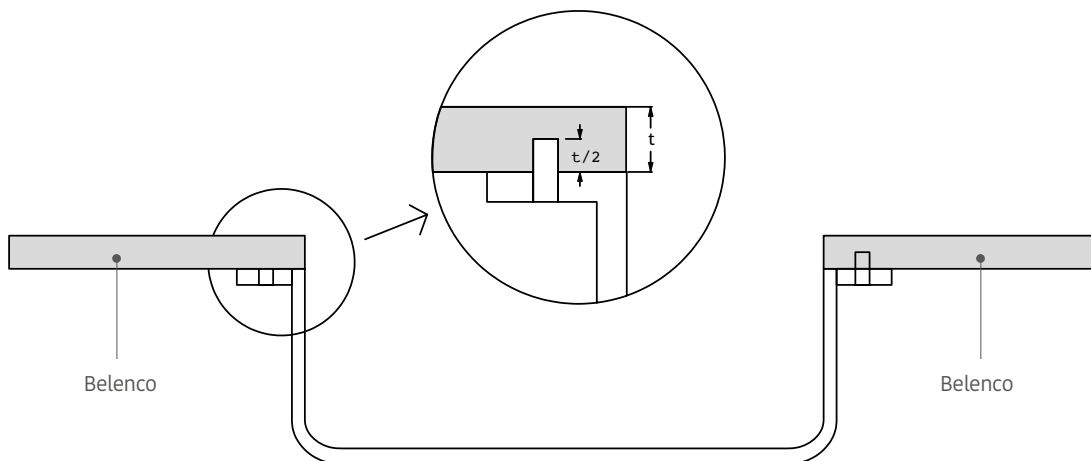

Large sink should be supported from below.

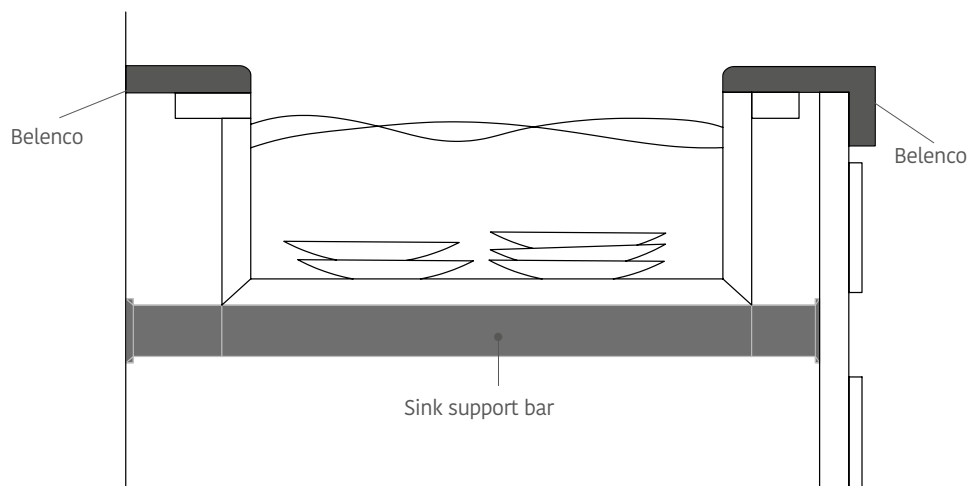

**Follow the manufacturer's instructions when placing the sink!**

## Distance between cooker and wall

- The distance between cooker and Wall Tile must be 70 mm.
- Follow the manufacturer's instructions

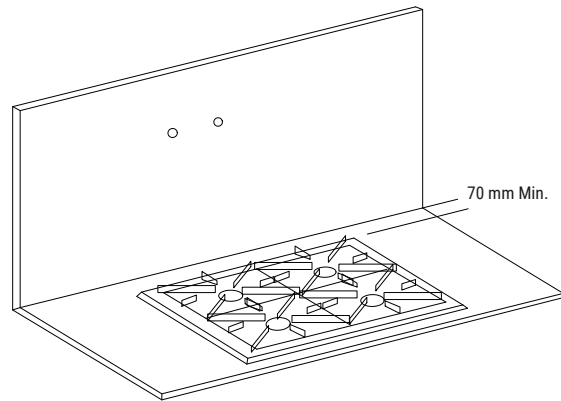

**Follow manufacturer's instructions while placing the cooker!**

## ●●● Edge Profiles



1



2



3



4



5



6



7



8



9



10



11



12



13



14



15

## Polishing Edge Profiles

- Use manual water polishing tools/machinery. Avoid using electric tools/machines as they are more dangerous due to water being used. Instead, use a pneumatic polishing machine.
- Follow the machine manufacturer’s instructions at all times to avoid incorrect use.
- Make sure the slab to be polished is properly supported to avoid movement during the polishing process.
- Check the polishing pads are in good condition. Use premium quality polishing pads for best results.
- Allow generous amount of clear water with continuous flow to prevent excessive heating of the surface and dust formation.
- Strictly avoid dry polishing as it results in excessive heating of the surface which in return disturbs the physical strength of the slab making it prone to surface damage and chipping.
- Use different polishing pads to achieve the surface finish you desire. For polished finish, we recommend that you use 50, 100, 200, 400, 800, 1.500, 3.000-grit diamond pads.
- Use lower rpm when using 1000-grit or higher diamond polishing pads. Pay special attention that the rpm is below 1.500.
- Never do any re-polishing, re-grinding, re-glossing, re-sanding or such other on the polished surface of the slab. Do not use any glossing agents. Always remember that any damage to the original factory surface polish is not covered by Belenco’s warranty.



**The edge polishing quality depends on many aspects such as the type of the tool, water and polishing pads being used as well as their speed and abrasive force. Therefore use appropriate tools with premium quality pads and apply the correct techniques properly**

## Lamination

- Belenco slabs are maximum 3 cm thick. In the case that a countertop edge is desired to be thicker than 3 cm, double edges/laminating is done.
- When cutting the piece to be laminated, add the lamination piece size to your cutting measurements. Try to cut the lamination strip from the same single slab as the countertop surface material to ensure that the lamination piece and the top piece are of the same length and color.
- When it is not possible to cut the lamination piece at the full length of the top piece and a joining of the lamination pieces is unavoidable, ensure that the joint in the lamination piece is at 45° to reduce any stress points.
- A 45° corner joint is recommended for all lamination pieces.

- To ensure strong adhesion, level off the surface of the part to be adhered. Pay special attention that the surface is free from dust and burrs.
- To ensure the correct elevation of countertop, support the back sides with support strips at each 50-60 cm gap.
- Spread the polyester lamination adhesive matching the color of the slab on both lamination surfaces and press the pieces making up the edge with clamps maximum 10 cm apart.
- Allow plenty of time for the adhesive to dry out.
- Once the adhesive is dried out, carry on with cutting and polishing.

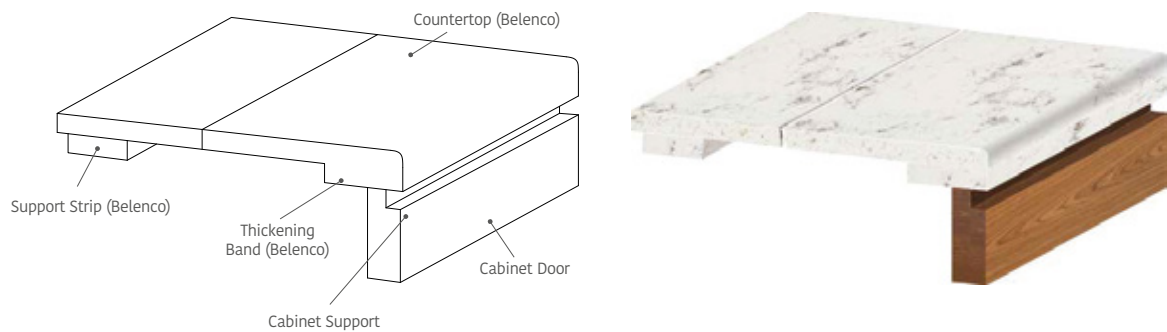

**In terms of application quality, easiness and fast application, we recommend using lamination adhesive.**

## Seaming

- Some countertop installations may require seaming. Carefully plan the location of seams together with your customer.
- Pay attention that the seams are not located over a dishwasher.
- Avoid cutting an L shaped countertop from one solid piece to the possible extent. Locate the seaming position at a corner. If an L shaped application is unavoidable, pay attention that the inside corner has a radius of minimum 20 mm.
- Drill a duct in the joints to ensure strong adhesion. Place extra adhesive on and around all joint surfaces.
- When fixing joints to each other, use a vacuumed leveling apparatus.
- Support all seams by placing support strips under the top piece.
- Never do surface glossing or wet polishing on seam surfaces. This will only damage the surface and damaged surfaces cannot be repaired. Always remember that anything which would damage the factory polish will not be at Belenco's responsibility.



Seam Setter

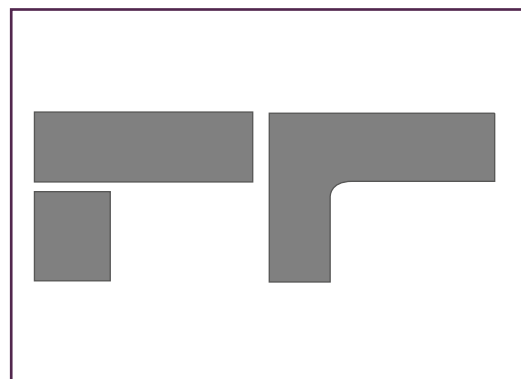

L Shape Countertop

## Mitered Edges

- Mitered edges are most prone to chipping.
- For strong adhesion and maximum performance of joints, do mitered edges at a 45° angle.
- Ensure that the joint is clean, smooth and parallel, and that the adhesive is thoroughly spread throughout the joint for maximum strength. Chipping is most common where the adhesive is not evenly distributed throughout the joint.

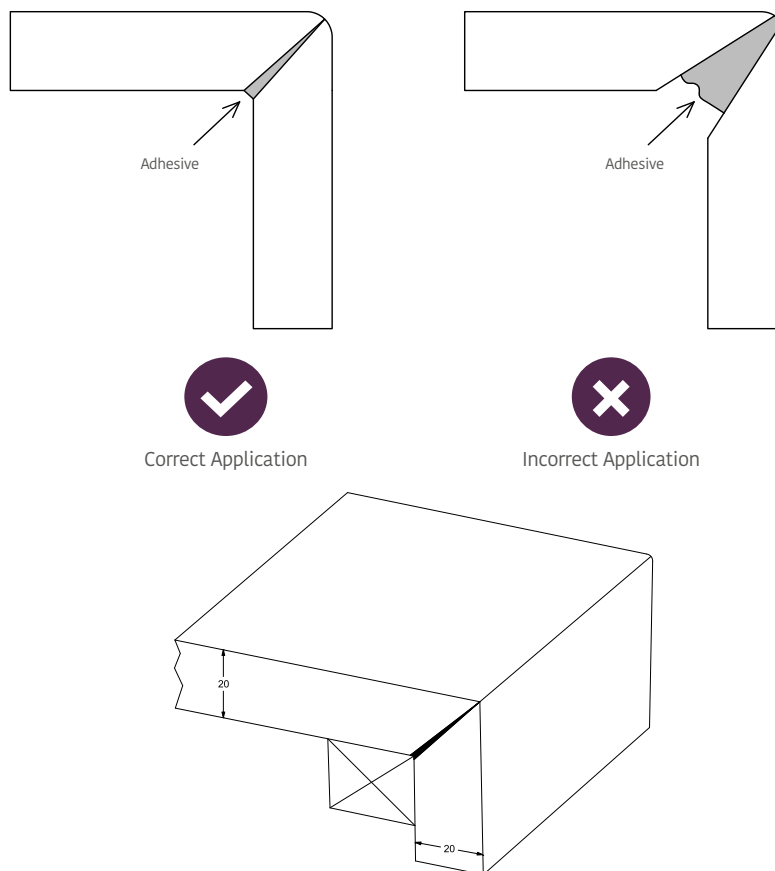

## Adhesives

- We recommend using polyester lamination adhesive for successful joint application.
- These adhesives can be colored with gel polyester pigments to obtain an adhesive with the closest color to the surface color.

## ●●● Installation Instructions

### Transportation of Materials

- Ensure that all countertop sections for a single application are ready for transportation without any missing piece.
- Transport sections on an iron “A” frame or a bundle to the installation site.
- Use straps to securely fasten sections to the rack to prevent them from sliding around. Give maximum consideration to fastening the sections.
- Rack the sections touching face-to-face on polished sides.
- Brace all cutouts to prevent flexing of the seams and corners.
- Transport sections vertically.



### Preparing the Job Site

- For a seamless joint application, we recommend the use of compatible polyester glue.
- Place the countertop sections vertically on the floor with the bare side down (chamfered edge facing the ceiling). Give due consideration to prevent sliding of the sections.
- Before starting with the installation, verify that the cabinets are level and fixed to each other and then secured to the back wall properly.
- Pay maximum attention that the cabinets are not damaged during installation.
- Check the size of countertop sections whether they fit their intended places and put them in order to determine the sequence of installation.
- Consider the sequence of seams to optimize installation.
- Never do any alteration, cutting or polishing at the job site.
- Any kind of dry polishing at the job site will damage the quartz surface.

## Installation

- Place the countertop on a strong framework or a perimeter frame.
- Allow a clearance space of min. 3 mm from each wall side for expansion of the countertop.

It is recommended to apply silicone between wall and countertop.

- Use support strips at each 50-60 cm gap along the countertop. We recommend that you use support strips made of quartz-based material, melamine faced MDF or plywood. Do not use marble or granite.

Do not use any materials that have low bearing capacity for such purposes. (We recommend that you conduct this application at your workshop prior to installation).

- Ensure that support is provided under all countertop joints.
- Note that support strips are required across the top of a dishwasher space whether there is a seam or not.
- Do not make any last minute changes at the job site. For instance, do not change the location of joint positions to correct any measurement mistakes. Such changes may result in damage to the countertop.
- Ensure that the sections to be joined are leveled.
- Do not fix the countertop to cabinets.
- Clean the excess silicone or polyester residues with acetone. It is recommended to be careful during this application. Acetone and silicone can damage furniture.
- Observe the manufacturer's instructions when installing sinks/basins/cookers.
- For under-mount sink and basin installations, 3-4 mm bevel is recommended around the cutout to reduce the risk of edge chipping.
- Support all sinks/basins and cookers properly independent of the countertop.



## Wallpanel Installation

- Make sure that the wall panel (eaves wall) to be covered is leveled.
- Remove dust from surface of the wall and the countertop panel.
- Before putting the prepared part in its place, check the size of the part again.
- Clean the joint surfaces of the parts with acetone.
- Apply point silicone to the wall and place the panel on the wall.
- Fill the gap between the panel and the counter with a silicone sealant.
- Do not use cement based adhesive etc.

## After Application

- Never allow any residues be left on the countertop surface and dry out after installation.
- Remove adhesive and silicone residues left on the top during installation right away. Always remember that the acetone you need to use for cleaning is not a cleaning agent actually, therefore do not forget to warn your customer never to use acetone for any surface cleaning afterwards.
- Carry out the final cleaning of the surface with the cleaning agents and in the manner as described in Belenco Maintenance & Care Guidelines.
- If further construction work is to be performed at the job site after the installation of the surface is complete, ensure that Belenco surface is properly protected by covering the entire top with a protective material to prevent any damage.
- Inform your customer that you and Belenco shall not assume any responsibility for any damage resulting from any further construction works to take place once after the countertop installation has been completed.
- Let your customer know that any successive trades must not use the new countertop as a workbench, a stepping or a standing platform during any further construction works after the installation.
- Make your customer aware that any trades using solvents or adhesives should take due care to avoid and/or remove any spills by their solvents or adhesives, and rinse the Belenco Quartz Surface with generous amount of water right away.
- Take a photograph of the actual installation and the written confirmation of your customer for proper documentation of their satisfaction with the material and workmanship at the end of the job.
- Make sure to leave Belenco Maintenance & Care Guidelines with your customer.





#### Headquarters and Factory:

**Factory I :**  
Manisa Organize Sanayi Bölgesi 4.Kısım  
Keçiliköy OSB Mah. Ahmet Nazif Zorlu  
Bulvarı No: 22  
Yunusemre - MANİSA / TÜRKİYE

**Factory II :**  
Manisa OSB 4. Kısım Keçiliköy OSB  
Mahallesi 418 Caddesi  
No:2 Yunusemre - MANİSA / TÜRKİYE

T: +90 236 213 03 43 F: +90 236 213 03 03  
E: info@belenco.com

#### İstanbul Office:

Akmerkez Residence Kültür Mah. Adnan Sa-  
ygun Cad. Ulus Yolu No: 3 K: 12 D: 12 A1 P. K.  
34340 Etiler - Beşiktaş - İSTANBUL / TÜRKİYE  
T: +90 212 871 20 95 F: +90 212 871 20 96  
E: info@belenco.com

